

Azione promozionale

THE NEW VALUE FRONTIER

 KYOCERA

Fresatura ad alto avanzamento

MFH BOOST



Promo Code:

MFH BOOST

Fino a **2,5mm** di ap in alto avanzamento per tutte le MFH BOOST con corpi fresa a partire dal diametro 22
Ampia gamma di applicazioni.

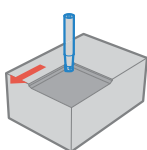

Spianatura e spallamento

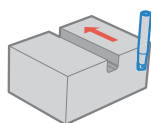

Scanalatura

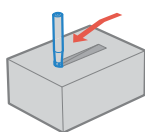

Lavorazione in rampa

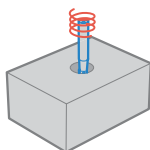

Fresatura elicoidale

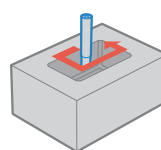

Svuotamento di cave

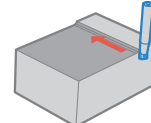

Contornatura

Testina filettata

dal $\varnothing 22$ al $\varnothing 42$



Candela

dal $\varnothing 22$ al $\varnothing 40$



Manicotto

dal $\varnothing 40$ al $\varnothing 80$



Acquistando **10** inserti per sede riceverete il **corpo fresa a condizioni speciali.**

Condizioni e termini commerciali

- Promozione a partire dal 19.03.2021.
- Promozione valida fino ad esaurimento scorte.
- Promozione non cumulabile con altre offerte speciali.
- Non verranno accettati ordini a programma.
- Non verranno accettate modifiche agli ordini come cancellazioni, cambi e resi.
- Salvo errori, ed eventuali modifiche.

Scansiona il QR per vedere i video



Fresatura ad alto avanzamento

MFH BOOST



Promo Code:

MFH BOOST

La MFH Boost permette di affrontare lavorazioni in alto avanzamento fino a **2,5mm**, completando la gamma MFH

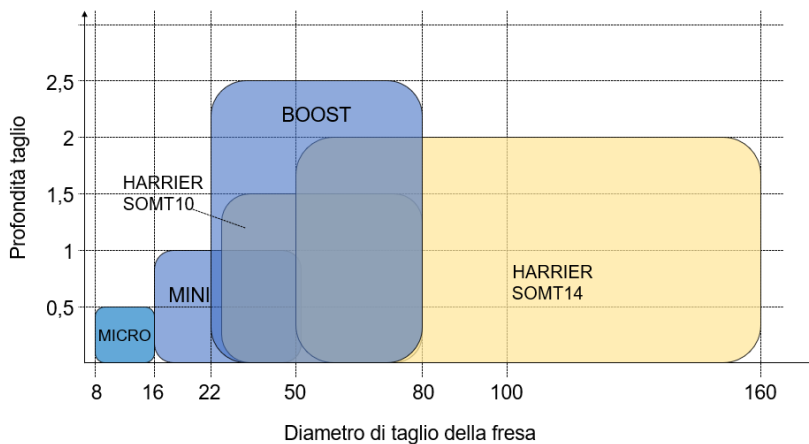

Il nuovo inserto LOMU04 montato sulla MFH BOOST permette a parità di diametro di avere corpi fresa a passo fine migliorando la produttività.

MFH Boost utilizza un nuovo inserto LOMU04 di forma simile all'inserto LOGU03 montato sul sistema MFH MINI, con dimensioni maggiori che ne aumentano l'affidabilità in condizioni gravose.

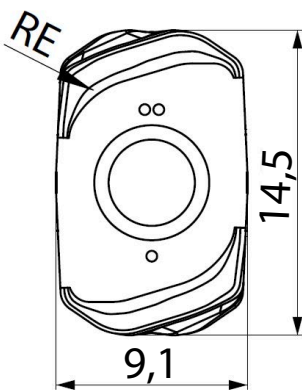

LOMU04

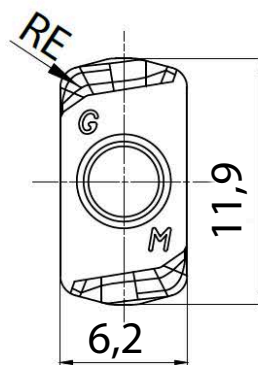
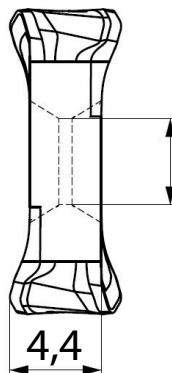

LOGU03

